



AS098C40W



TECHNICAL DATA

High Power Stacked Infrared Laser Diode Array

Features

- Output Power: 40 W
- 920-980 nm Emission Wavelength
- Spectral Width: ≤ 4 nm
- High Reliability, High Efficiency
- CW stack arrays adopt micro-channel package

Applications

- Laser Pumping
- Medical Usage
- High power laser diode applications

Specifications (25°C)

Item	Symbol	Value	Unit
Optical Specifications			
CW Output Power	P_O	40	W
Output Power / Bar	P_S	20	W
Array Length	L	10	mm
Center Wavelength	λ_C	920-980	nm
Wavelength Tolerance		± 5	nm
Spectral Width	$\Delta\lambda$	≤ 4	nm
Package Style		Micro Channel	
Bar Length		1.6	mm
Number of Bars		2	
Wavelength Temperature Coefficient		0.3	nm/°C
Beam Divergence	$\theta_{\perp} \times \theta_{\parallel}$	40x8	deg
Electrical Specifications			
Slope Efficiency	E_S	≥ 0.8	W/A
Conversion Efficiency	N_S	$\geq 30\%$	
Threshold Current	I_{TH}	≤ 10	A
Operating Current	I_F	≤ 30	A
Operating Voltage	U_F	≤ 4	V
Absolute Maximum Ratings			
Reverse Voltage	U_R	2.5	V
Operating Temperature	T_{OP}	+10 ... +40	°C
Storage Temperature	T_{STG}	-40 ... +85	°C





Package Dimensions

Micro Channel (Unit:mm)

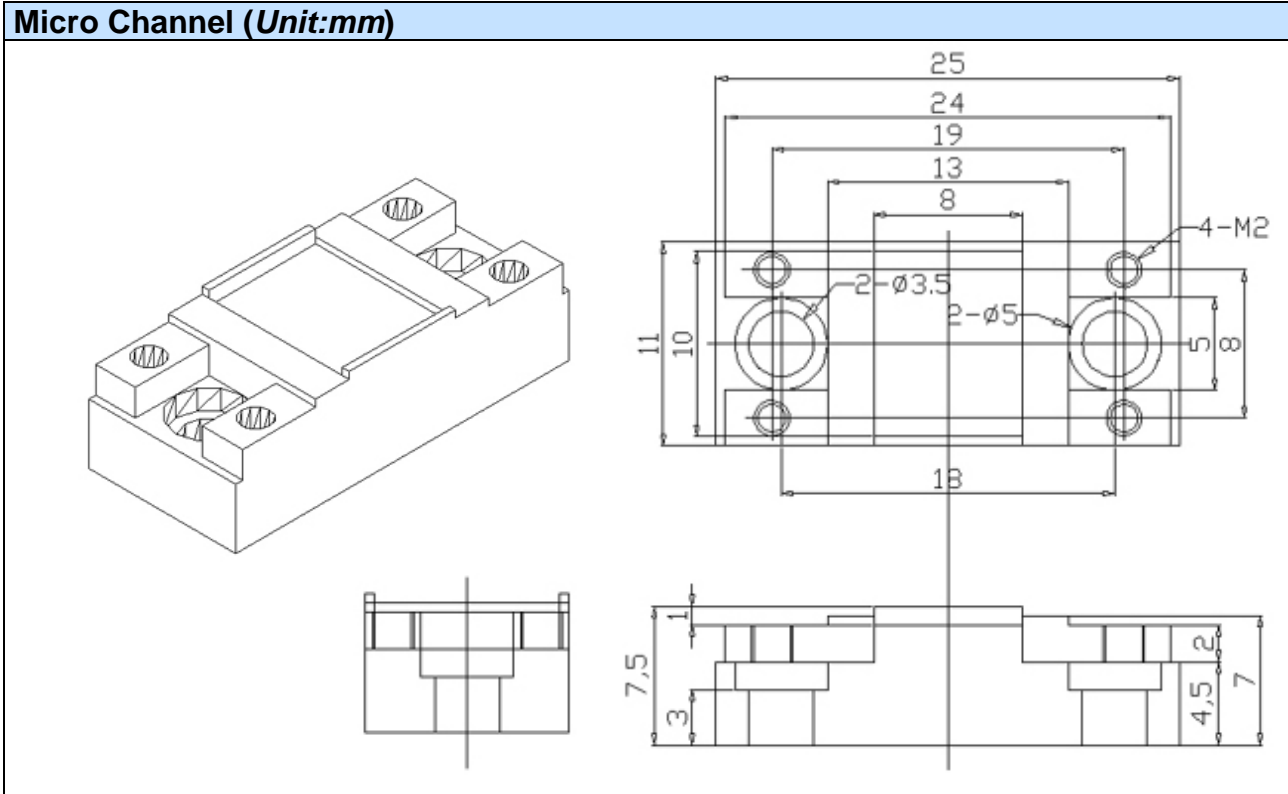

Notes

1. Caution! Don't look at the laser beam directly, because it's harmful to eyes.
2. The storage temperature is between -40 and 85 °C.
3. Under normal circumstances, the higher the temperature is, the shorter the life of semiconductor laser will be. It is recommended to use lasers under TEC cooling or in air-conditioned room.
4. To use a laser diode in following sequences: Turn on the power supply; connect to the laser diode; and then increase the current gradually to the specified operating value. To shut down the laser diode, please decrease the current to zero gradually, and then turn off the power. Please make sure that the power supply has no current overshoot at any time. The current overshoot can damage the laser diodes permanently.
5. The high power laser diode arrays are very sensitive to electrostatic. Please wear anti-static bracelet during operating with the laser diodes (arrays).
6. Be sure that the operating current does not exceed the specified operating current. Otherwise, it will accelerate laser aging, shorten lifetime or even damage devices permanently.
7. A clean, dry and ventilated environment should be available when storing and operating laser diodes (arrays). Dust may degrade the laser diodes (arrays).
8. Constant-current power supply with voltage regulator should be used to avoid surge.