

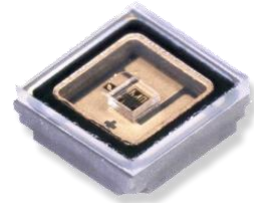

## DUV310-SD351EV

- Deep Ultraviolet Light Emission Source
- 308nm, 19 mW @ 100 mA
- ESD protection
- Flat UV window
- Beam angle 120 deg.



### Description

**DUV310-SD351EV** is an AlGaIn based single emitter **DEEP-UV LED** with a typical peak wavelength of **308 nm** and an optical output power of typically **19 mW @ 100 mA** in a sealed 3535 metal SMD package. It features an **integrated ESD protection** device and UV glass window. **DUV310-SD351EV** is ready for reflow soldering process, and can be delivered on tape. Wavelength binning is available on request

### Absolute Maximum Ratings



Parameter	Symbol	min.	max.	Unit
Forward Current	$I_F$		150	mA
<b>Junction Temperature</b>	$T_J$		<b>90</b>	<b>°C</b>
Operating Temperature	$T_{OPR}$	- 30	85	°C
Storage Temperature	$T_{STR}$	- 40	85	V

### Electro-Optical Characteristics ( $T_{CASE} = 25^{\circ}C$ , $I_F = 100$ mA)

Parameter	Symbol				Unit
		min.	typ.	max.	
Peak Wavelength*	$\lambda_P$	303	308	313	nm
<b>Radiated Power**</b>	$P_O$		<b>19</b>		<b>mW</b>
Spectral Width (FWHM)	$\Delta\lambda$		15		nm
Forward Voltage	$V_F$		5.4		V
<b>Viewing Angle</b>	$2\theta_{1/2}$		<b>120</b>		<b>deg.</b>

\*Peak Wavelength measurement tolerance is  $\pm 3$ nm

\*\*Radiated power measurement tolerance is  $\pm 10\%$

 <b>WARNING</b>	
	<ul style="list-style-type: none"> <li>• LEDs emit very strong UV radiation.</li> <li>• Do not look at the LED light with the naked eye or irradiate the skin. UV radiation can harm your eyes and skin.</li> <li>• To prevent UV radiation exposure, wear protective eyewear and protective equipment.</li> <li>• If LEDs are embedded in devices, please indicate warning labels against the UV light LED used.</li> <li>• Keep out of reach of children.</li> </ul>



## Performance Characteristics

### Forward Current vs. Forward Voltage

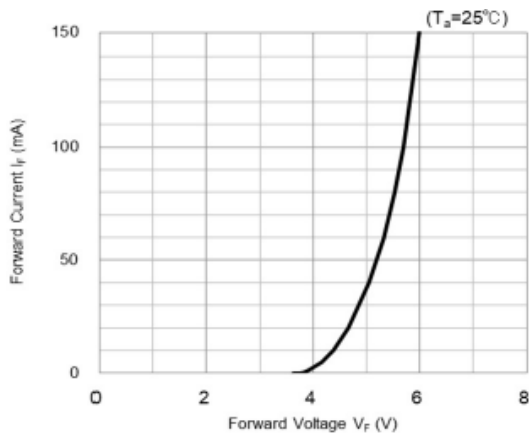

### Rel. Optical Power vs. Forward Current

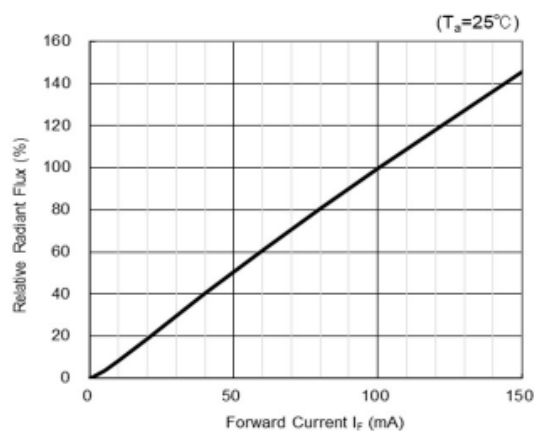

### Spectrum

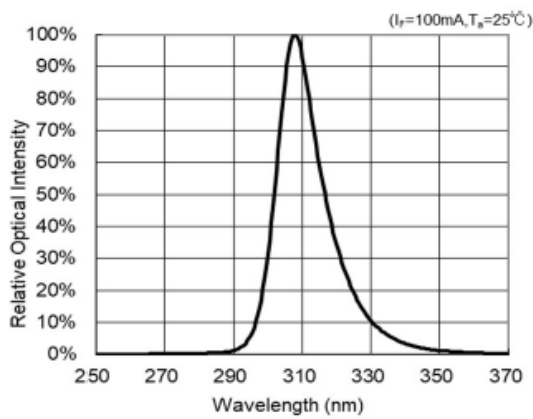

### Forward Current vs Ambient Temperature

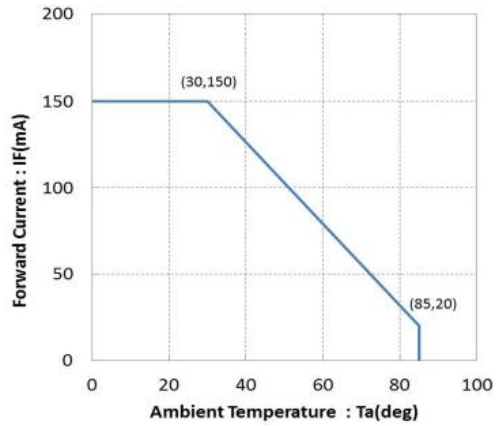

### Radiation Pattern

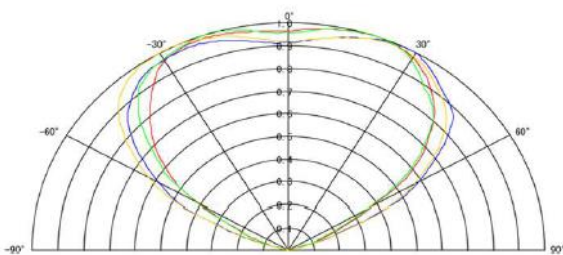

/

Intentionally blank



## Outline Dimensions

### SMD 3535

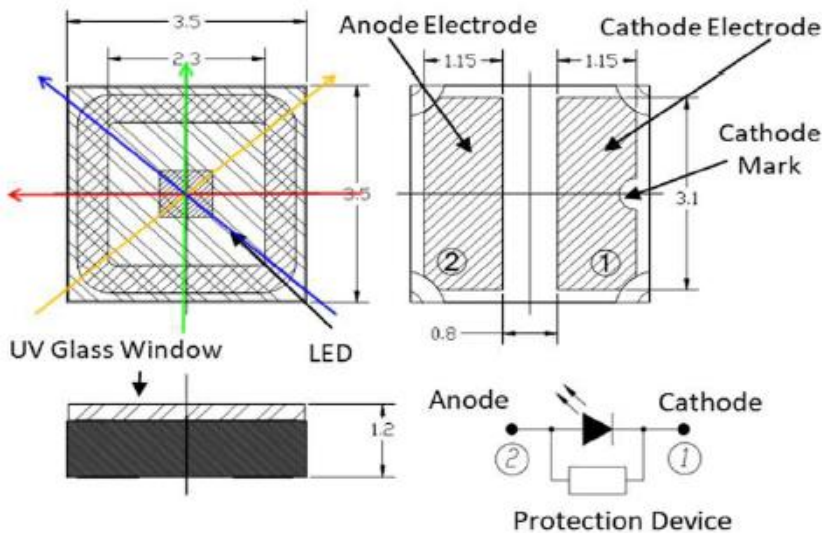

all dimensions in mm

## Soldering Information

### Solder Pad Layout

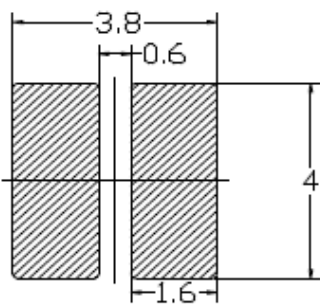

- all dimensions in mm
- drawing not to scale

### Reflow Soldering Profile

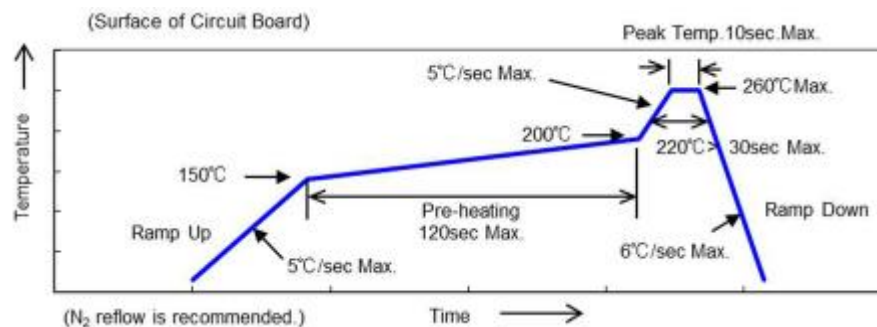

- JEDEC-J-STD-020C

## Accessories

### SD35-PCB

A printed **Cu circuit board** with Ni finish and Au contact plates, designed for easily soldering and mounting the SD35 series LEDs. Ideally suited for prototyping and evaluation

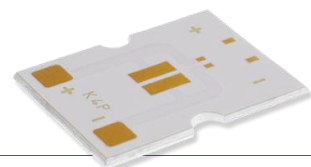



## Precautions

### Static Electricity

LEDs are sensitive to electrostatic discharge (ESD). Precautions against ESD must be taken when handling or operating these LEDs. Surge voltage or electrostatic discharge can result in complete failure of the device.



### UV-Radiation

During operation these LEDs do emit **high intensity ultraviolet light**, which is hazardous to skin and eyes, and may cause cancer. Do avoid exposure to the emitted UV light. **Protective glasses are recommended.** It is further advised to attach a warning label on products/systems that do utilize UV-LEDs:



### Operation

**Do only operate LEDs with a current source.**

Operating these LEDs from a voltage source *will* result in complete failure of the device. Current of a LED is an exponential function of the voltage across it. Usage of current regulated drive circuits is mandatory