



SMB1N-1150D-02

- Infrared High Power LED
- 1150 nm, 260 mW
- InGaAsP chip, 1000 x 1000 μm
- PA9T SMD package
- Beam Angle: $\pm 9^\circ$



Description

SMB1N-1150D-02 is a surface mount InGaAsP based high power infrared LED, with a typical peak wavelength of 1150 nm and optical output power of 260 mW @ 1 A. It comes in polyamide resin SMD package (PA9T) with silver plated soldering pads (lead free solderable), copper heat sink, and silicone resin molded lens. Additional variants with different beam angles are available on request.

Maximum Ratings*

Parameter	Symbol	Values		Unit
		Min.	Max.	
Power Dissipation	P_D		3600	mW
Forward Current	I_F		1500	mA
Pulse Forward Current **	I_{FP}		4000	mA
Reverse Voltage	U_F		5	V
Thermal Resistance	R_{THJA}		10	K/W
Junction Temperature	T_J		120	$^\circ\text{C}$
Operating Temperature	T_{CASE}	- 40	+ 100	$^\circ\text{C}$
Storage Temperature	T_{STG}	- 40	+ 100	$^\circ\text{C}$
Lead Solder Temperature (t_{max} 5s)	T_{SLD}		+ 250	$^\circ\text{C}$

* Operating close to or exceeding these parameters may damage the device

** duty cycle = 1 %, pulse width = 10 μs

Electro-Optical Characteristics ($T_{CASE} = 25^\circ\text{C}$)

Parameter	Symbol	Conditions	Values			Unit
			Min.	Typ.	Max.	
Peak Wavelength	λ_P	$I_F=1\text{ A}$	1100		1200	nm
Half Width	λ_Δ	$I_F=1\text{ A}$		70		nm
Forward Voltage	V_F	$I_F=1\text{ A}$		1.4	1.8	V
	V_{FP}	$I_{FP}=2\text{ A}^*$		1.8		
Total Radiated Power	P_O	$I_F=1\text{ A}$	150	260		mW
		$I_{FP}=2\text{ A}^*$		480		
Radiant Intensity	I_E	$I_F=1\text{ A}$		1000		mW/sr
		$I_{FP}=2\text{ A}^*$		1800		
Beam Angle	$2\theta_{1/2}$	$I_F=100\text{ mA}$		18		deg.
Rise Time	t_r	$I_F=1\text{ A}$		90		ns
Fall Time	t_f	$I_F=1\text{ A}$		30		ns

* duty cycle = 1 %, pulse width = 10 μs



Typical Performance Curves

Forward Current vs. Forward Voltage

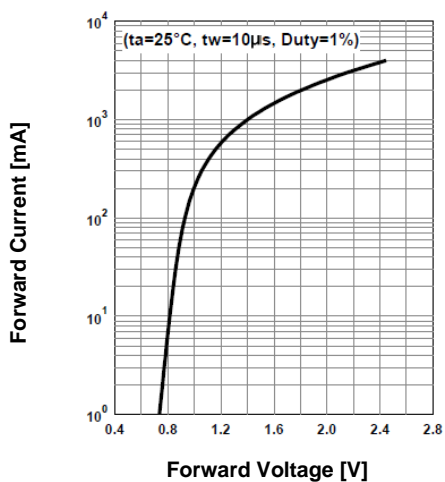

Relative Radiant Intensity vs. Forward Current

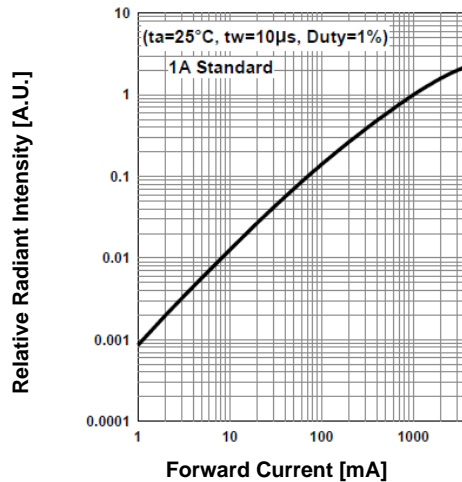

Forward Current vs. Pulse Duration

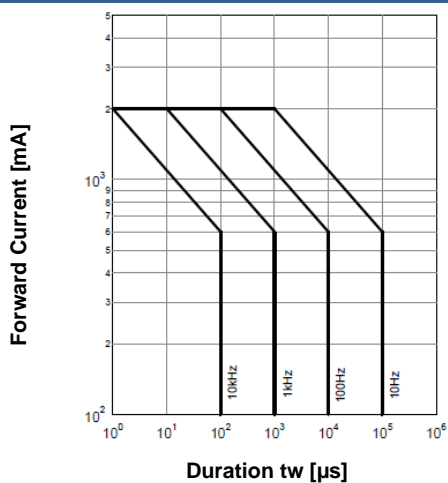

Allowed Forward Current vs. Amb. Temperature

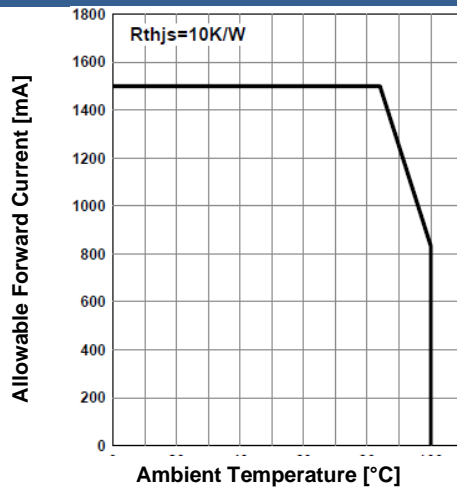

Forward Voltage vs. Ambient Temperature

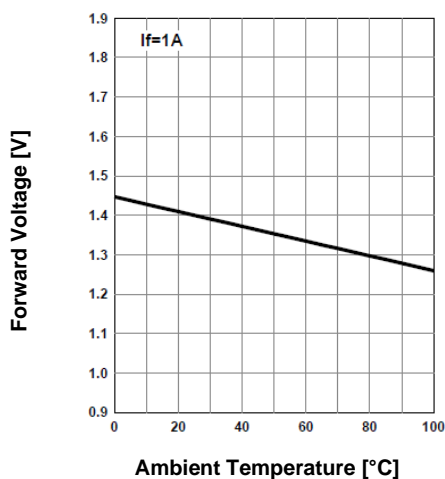

Rel. Radiant Intensity vs. Ambient Temperature

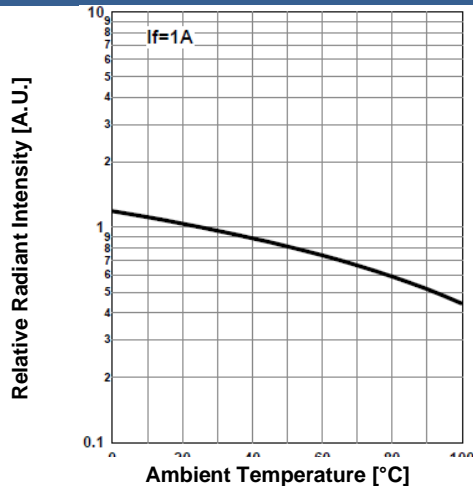



Typical Performance Curves

Peak Wavelength vs. Amb. Temp.

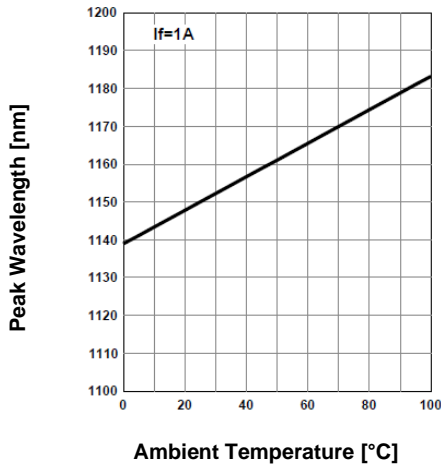

Relative Spectral Emission

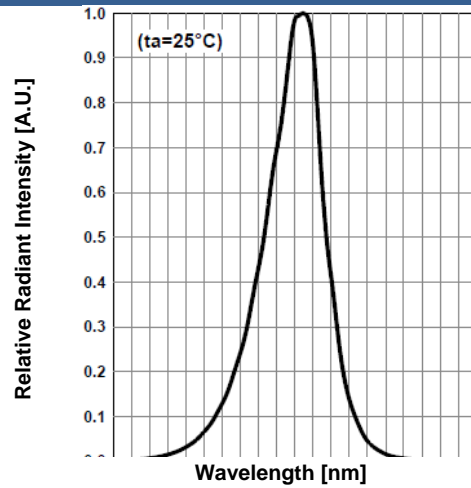

Radiation Characteristics

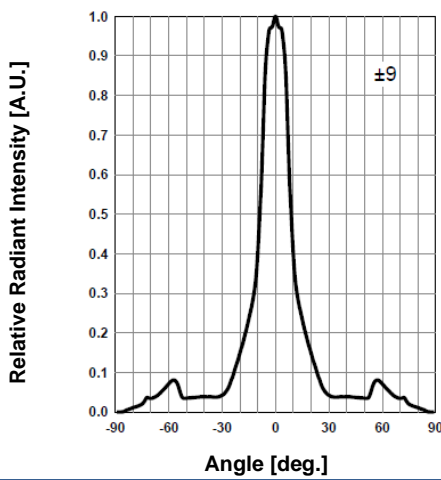

Radiation Characteristics

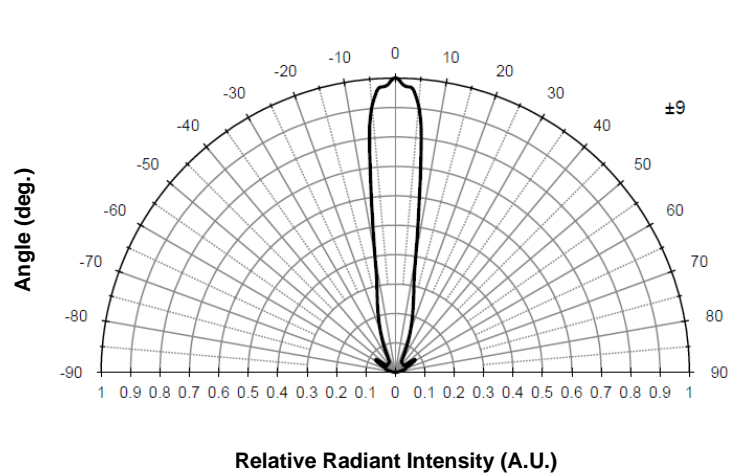

Outline Dimensions

PA9T

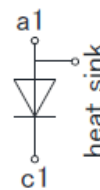
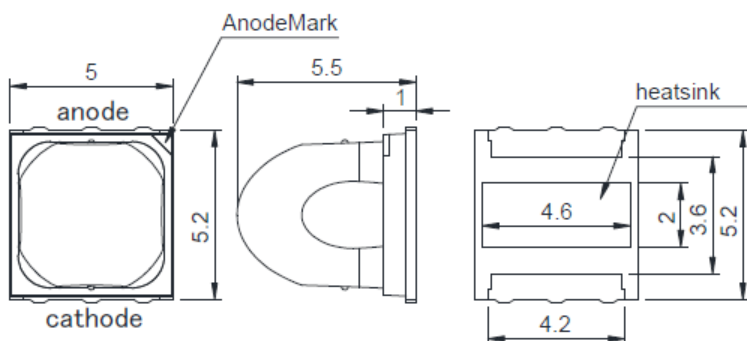

Lead	Function
Pin a1	Anode
Pin c1	Cathode

all dimensions in mm



General Notes

Soldering

- Do avoid overheating of the LED
- Do avoid electrostatic discharge (ESD)
- Do avoid mechanical stress, shock, and vibration
- Do only use non-corrosive flux
- Do not apply current to the LED until it has cooled down to room temperature after soldering

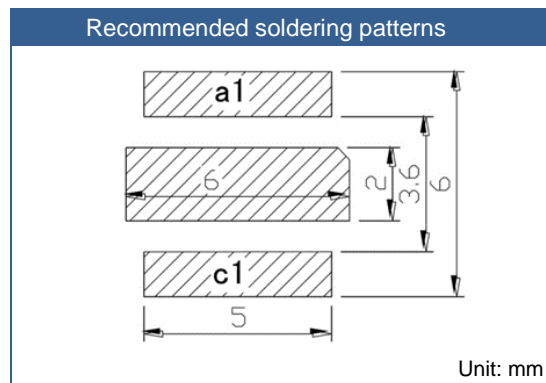
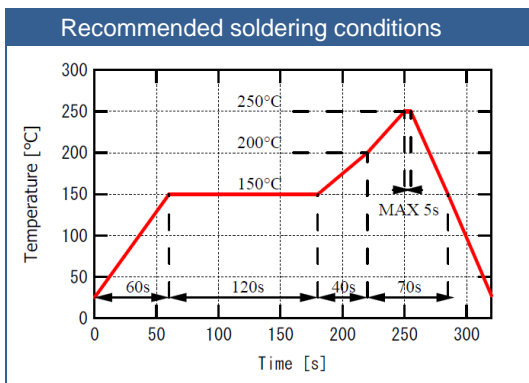

Cleaning

- **Cleaning with isopropyl alcohol, propanol, or ethyl alcohol is recommended**
- DO NOT USE acetone, chloroform, trichloroethylene, or MKS
- DO NOT USE ultrasonic cleaners

Static Electricity

- **LEDs are sensitive to electrostatic discharge (ESD).**
- Precautions against ESD must be taken when handling or operating these LEDs
- Surge voltage or electrostatic discharge can result in complete failure of the LED.

Radiation

- During operation these LEDs do emit light, which **could be hazardous to skin and eyes, and may cause cancer.**
- Do avoid exposure to the emitted light. Protective glasses if needed
- It is further advised to attach a warning label on products/systems.

Operation

- **Do only operate LEDs with a current source.**
- Running these LEDs from a voltage source will result in complete failure of the device.
- Current of a LED is an exponential function of the voltage across it. Usage of current regulated drive circuits is mandatory.

Storage

- The **maximum shelf life** of LEDs in the originally sealed aluminum bag is **12 months**.
- Before opening the aluminum bag, please store it at **<30 °C, <60 % RH**.
- After opening the aluminum bag, please solder the LEDs within **72 hours (floor life)** at **5 – 30 °C, <50 % RH**.
- Put any unused, remaining LEDs and silica gel back in the same aluminum bag and then vacuum-seal the bag.
- It is recommended to keep the re-sealed bag in a desiccator at <30%RH.